

Trends in Microwave/Millimeter-Wave Front-End Technology

Gailon E. Brehm

TriQuint Semiconductor, Richardson, Texas, 75080, USA

Abstract — Unique, high-performance components are utilized between the air or fiber-optic media interface and baseband/digital signal processing functions. TriQuint and other suppliers have developed power amplifiers, filters, duplexers, switches, phase shifters, and frequency conversion components specifically for this niche in systems ranging from RF-frequency cellular handsets to millimeter-wave frequency point-to-point radio transceivers. Examples of the use of specialized front-end technologies are: combining surface acoustic wave devices with GaAs switches and power amplifiers in a handset modules, linear millimeter-wave power amplifiers for point-to-point radio links, millimeter wave switches using GaAs PIN diodes, and combining GaAs HBT, PHEMT, and VPIN technology in a 77-GHz Tx/Rx front-end for automotive radar. Finally, future GaN HEMT technology is showcased by discrete transistors setting new levels of power density.

Index Terms — MMICs, MIMICs.

I. INTRODUCTION

Critically situated between the air or fiber-optic media interface and baseband and digital signal processing functions in a range of electronic systems are demanding front-end RF functions. Because of the wide range of frequencies utilized and the high levels of performance required, a mix of silicon and non-silicon technologies is typically used. TriQuint and others have established product lines focusing on this niche. Microwave and millimeter-wave communication systems, radars, and radiometric sensors are examples of systems benefiting from the recent improvements in technology working within this functional space.

II. RF/MICROWAVE TECHNOLOGIES

Cellular telephone handsets, operating in bands near 1 and 2 GHz, now include multi-band, multi-mode radio front ends in the same or smaller form factor than earlier single-mode models. Today's typical RF section of such an handset utilizes integrated transceivers in silicon CMOS or BiCMOS coupled with power amplifiers, switches, filters, or duplexers. A mix of GaAs HBT, GaAs PHEMT, and surface acoustic wave technologies are typically used for these latter functions. In addition, these functions are rapidly being combined in miniature, surface-mount modules, allowing handsets to continue to shrink as the radio functions have multiplied. Examples of such surface-mount module solutions from TriQuint are shown in Figure 1. Highly integrated RF modules shown include a transmit module combining InGaP HBT PA, SAW filters and duplexers, power detectors and

couplers and a front-end module combining PHEMT switches and SAW filters.



Fig. 1. HBT, PHEMT, and SAW technologies are combined in module form to simplify front end functions in the Transmit Module (PA, filter, detector) and Front-End Module (switching, filtering).

III. MILLIMETER-WAVE TECHNOLOGIES

Point-to-point radios are being rapidly deployed to provide backhaul links to cellular telephone base stations and other high-bandwidth data links. These systems operate at X-band frequencies and above, requiring III-V compound semiconductor devices for the RF front end. Popular links at 23 and 38 GHz have become practical as GaAs PHEMT MMICs, optimized for millimeter-wave frequencies, have become available. GaAs PHEMT MMIC power amplifiers typify the technology used at these frequencies. Figure 2 shows a TriQuint 18 - 26 GHz 1W PHEMT power amplifier available in both chip and packaged format. In the past, most millimeter-wave front-end modules were built using bare GaAs HPAs and other chips in a multi-chip hybrid module format with ceramic transmission media. Today, more and more effective use is being made of surface-mount MMICs on multi-layer boards. Accordingly, the 1W K-band HPA is now available in leadless, surface-mount form (Figure 2).

Given the need for higher transmit output power, Kong [1] has reported a 30-GHz, 4W, 3-stage PHEMT MMIC power amplifier with total chip area of 8.63 mm², Figure 3. This compact, high-performance Ka-band design utilizes TriQuint's 0.15- μ m PHEMT transistor technology and 50- μ m thick substrates with slot vias for compact, high-performance FET unit cells.

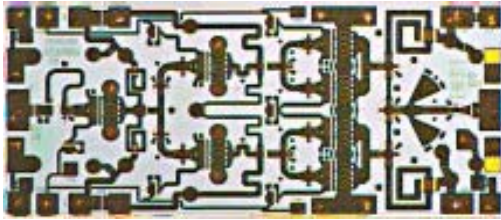

Fig. 2. 30-GHz PHEMT HPA in chip and packaged forms, TGA4509 and TGA4509SM

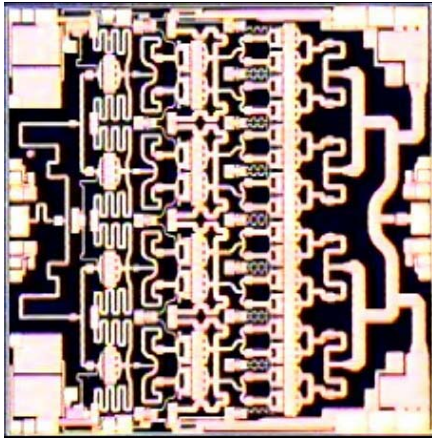

Fig. 3. Compact 4-W Ka-band PHEMT high-power amplifier.

In addition to high-performance power amplifiers, today's millimeter-wave front ends utilize multi-function MMICs combining power and low-noise amplifiers along with switching and frequency conversion. TriQuint's 0.15- μm PHEMT process allows an excellent combination of these functions on a single chip. Operating in the 3 to 6V drain bias range, this process combines low noise figure (1dB at 26 GHz), high power density (.8W/mm) and good linearity (>35 dBm OTOI) from a 300- μm unit cell. Excellent noise figure is seen even at 6V drain bias. These factors combined with low-loss switch performance and proven quality and reliability make this process an excellent choice for next generation designs. In addition, this process provides three levels of interconnect metal to facilitate circuit compaction. Figure 4 shows millimeter-wave power and noise data for a 300- μm transistor cell in this PHEMT process.

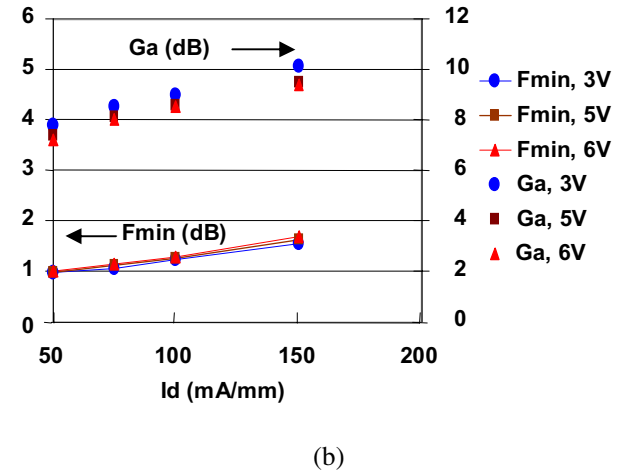
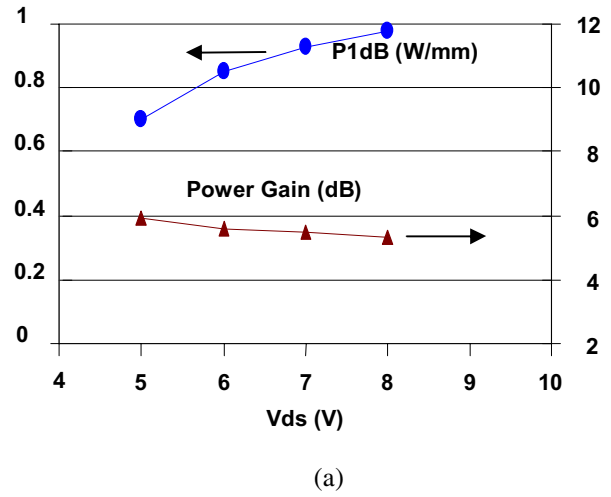

Fig. 4. Characteristics of TriQuint 0.15- μm PHEMT process: (a) 35 GHz output power density and gain versus drain voltage for a 300 μm PHEMT, (b) Minimum noise figure (Fmin) and associated gain (Ga) at 26 GHz as a function of drain current density for a 300 μm PHEMT.

PHEMT technology is particularly well suited for extremely low-power-consumption millimeter-wave switching. This switching capability enables complex, multi-throw switch matrixes as well as compact 5 or 6-bit phase shifters. Campbell [2] has reported the development of a K-band phase shifter suitable for satellite phased arrays. Similar techniques are incorporated in the TriQuint 30-GHz 5-bit phase shifter shown in Figure 5. These circuits make use of quarter-micron gate PHEMT technology for high switch figure of merit along with through-substrate vias and gold conductors for maximum circuit flexibility and lowest loss.

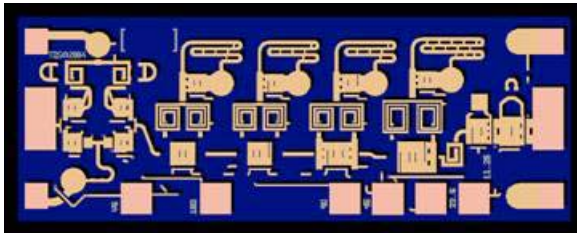

Fig. 5. TriQuint TGP2100 30-GHz 5-Bit PHEMT Phase Shifter

Automotive radar systems at 77 GHz and 81 GHz are expected to be pervasive during the next decade providing multiple function such as adaptive cruise control, collision warning, lane change assistance, and parking/backup assistance. Systems based on the functional block diagram of Figure 6, with modifications to the number of ports, etc., to accommodate the desired antenna configuration, can be configured to accomplish the above modes. GaAs technologies have been applied to chips for each of the functions shown. For the switch matrix where low RF loss good isolation and low VSWR are required, GaAs VPIN appears to be the optimal technology. This is because of the low off-state capacitance and low on-state resistance of PIN and the fact that GaAs VPINs are fabricated on semi-insulating substrates along with all the other features of MMICs. For the amplifiers and frequency multipliers in this chip set, eighth-micron PHEMT is used. PHEMT provides good gain, power, and noise figure at 80 GHz and is routinely manufactured. The VCO and mixer chips, however, need low $1/f$ noise characteristics since many automotive radars use a homodyne FMCW architecture. The vertical transistors and diodes implemented within TriQuint's InGaP HBT MMIC process have low intrinsically low noise at baseband frequencies and have been utilized for these two chips. Each of the chip set functions has been implemented in GaAs at TriQuint as is illustrated in Figure 6.

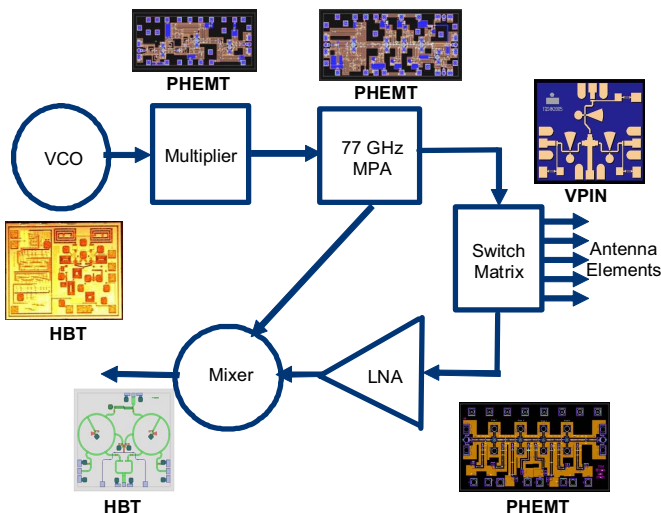

Fig. 6. GaAs 77 / 81 GHz automotive radar front-end chip set.

For the current generation, three GaAs technologies have been selected to optimize the performance of the automotive radar chip set. Each of these chips can be made quite small; so that initial cost will be moderate. In the future more highly integrated versions of the chip set are expected.

In the 80 - 100 GHz frequency range, passive radiometric imaging becomes quite useful not only for deep space but also for terrestrial applications. MHEMT technology makes possible low-noise integrated circuits in that frequency band. Fabricated on GaAs substrates and utilizing the same MMIC circuits elements as GaAs PHEMT, MHEMT transistors provide significantly more gain and lower noise by means of the enhanced channel materials used. Shown in Figure 7, TriQuint has developed a complex balanced MHEMT LNA that provides 25 dB gain with 5.5 dB noise figure in the 80 - 100 GHz frequency range.

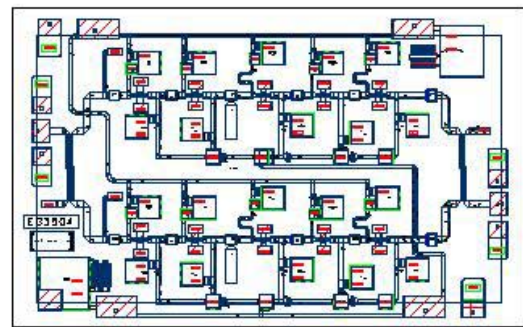

Fig. 7. 80 - 100 GHz balanced MHEMT low-noise amplifier.

IV. FUTURE TECHNOLOGY

Beyond the III-Vs, GaN HEMT technology has the potential to revolutionize RF/microwave integrated circuits. GaN is a widebandgap semiconductor that retains the high frequency response with the same or higher current density capability of GaAs while allowing 3 - 5X higher operating voltage. The resultant step-function increase in speed for high power switches or in power density for transistor amplifiers will enable much more compact circuits operating at voltages more suitable for high-power operation. When mature, this new technology should allow redesign of existing low-voltage (<10V) MMICs for operation at supply voltages of 28 - 100V or above.

At present, GaN transistors are available for L- to S-band operation but integrated circuits have not yet reached maturity. It appears that the technology is maturing rapidly and circuit level optimization should soon be complete to the point that the promise of this technology can be demonstrated in a practical way.

Perhaps the best indication of the tremendous potential for GaN is transistor performance at 30 GHz. For performance at millimeter-wave frequencies, the intrinsic frequency

capability of the transistor must be retained while high voltage/high-power operation is demonstrated. Figure 8 shows the performance of a TriQuint GaN-on-SiC test cell (200 μm) at 30 and 35 GHz. This 0.25- μm gate device was seen to perform at 30V with high power density, good efficiency and gain. The data of Figure 8 were taken on a load pull station to allow optimization of the load impedance for this device. Performance achieved was 4.1 W/mm, 6.9 dB Gain, and 33% PAE at 30 GHz with an operating voltage of 30V. At 15V drain bias, 2.8W/mm with 44% PAE was achieved. These gain and efficiency results are comparable with GaAs PHEMT and the power density is approximately 3X to 5X higher.

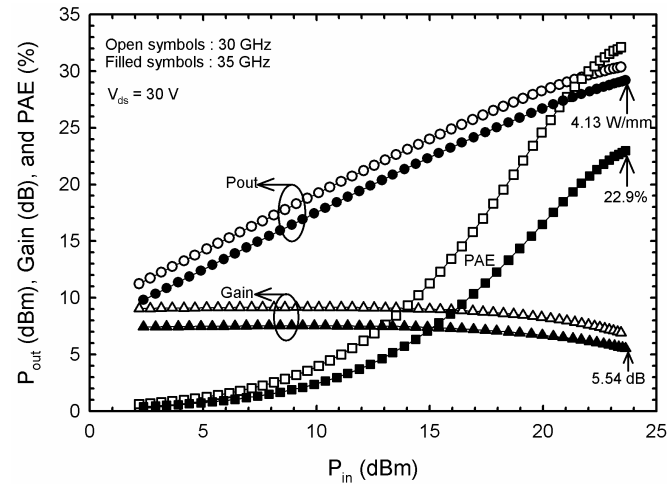

Fig. 8. Output power density at peak PAE as a function of drain bias measured at 30 and 35 GHz for a 200- μm AlGaIn/GaN HEMT on SiC substrate.

VII. CONCLUSION

A mix of technologies is preferred at the front-end of microwave and millimeter-wave communications, radar, or sensor systems. These specialized technologies provide the needed performance depending on the frequency, power or other key feature needed by individual systems. GaAs PHEMT and HBT are pervasive in such applications.

REFERENCES

- [1] K. S. Kong, B. Nguyen, S. Nayak, and M. Y. Kao, "Ka-Band MMIC High Power Amplifier (4W at 30 GHz) with Record Compact Size," *2005 IEEE Compound Semiconductor IC Symp. Dig.*, pp. 232-235, November 2005.
- [2] C. F. Campbell and S. A. Brown, "A Compact 5-Bit Phase Shifter MMIC for K-Band Satellite Communication Systems," *2000 MTT-S Int. Microwave Symp. Dig.*, 00.1 (2000Vol. I [MWSYM]), pp. 217-220, June 2000.
- [3] C. Lee, P. Saunier, J. Yang, and M. A. Khan, "AlGaIn/GaN HEMTs on SiC with CW Power Performance of > 4 W/mm and 23% PAE at 35 GHz," *IEEE Electron Device Lett.*, vol. 24, no. 10, pp. 616-618, Oct. 2003.